

Mechanical Face Seals Overview



SEALCO
INTERNATIONAL LTD

High performance in the most demanding environments

UK suppliers of



For decades SAP Parts™ branded Mechanical Face Seals have been the choice of OEMs and users of extreme environment sealing systems with enormous success.

This makes SAP Parts™ Mechanical Face Seals an ideal product to include in Sealco International LTD's extensive portfolio of high performance sealing solutions.

Sealco International's collaboration with SAP Parts™ allows UK users access to both local sales and technical support of mechanical face sealing products. We have direct access to an extensive European stock ensuring minimal delivery times.

Our sales team have extensive knowledge in the application of these products and work directly with the manufacturer's technical team should the need for additional engineering input be required.

Mechanical face seals are designed to be used in the most demanding environments, often used in challenging applications where traditional sealing solutions cannot perform.

In applications from construction equipment through to transmissions, axles, rollers and agricultural equipment, often high stresses coupled with harsh environments such as sand, dirt, mud and other abrasive media rule out the use of many sealing systems.

SAP Parts™ offer a range of sealing solutions specially designed for use in these conditions.



Mechanical Face Seals

Mechanical face seals consist of two special alloy cast seal rings with hardened and precision lapped faces, these rings are energised by two high quality elastomer rings.

These seals are designed to open out from the faces towards the centre axis.

These design features ensure that:

A capillary effect coupled with centrifugal forces ensure easy access of lubrication to the sealing faces, resulting in longer seal life and preventing cold welding of the seal faces.

Adequate lubrication prevents high temperature build up.

Elastomer energisation ensures that a constant preload is applied to the sealing faces compensating for both wear and thermal movement between the faces.

Static preload is present ensuring both static and dynamic performance.

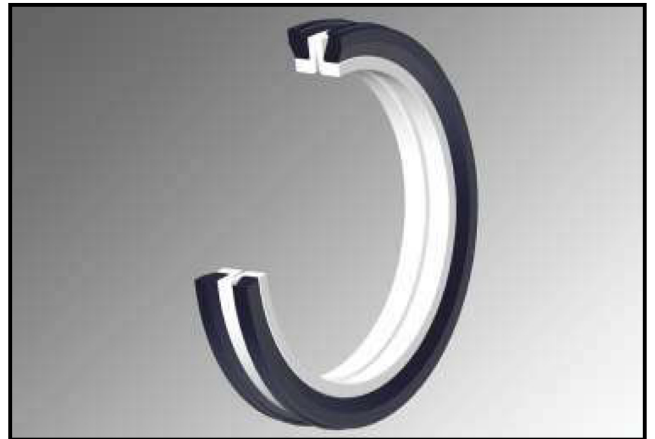

Benefits of using SAP Parts™ Seals

Circumferential speeds of up to 10 ms⁻¹ are achievable.

Constant face contact ensuring excellent static and dynamic sealing performance.

Excellent heat dissipation when properly lubricated.

Reliability in the harshest of environments

In selecting SAP Parts™ mechanical face seals, you can be reassured that decades of experience have been applied to the development of these premium products and can be confident that you are using the optimum product for your application.

Mechanical Face Seal DO Type

DO type mechanical seals consist of two identical metal face seals with two elastomeric o-rings positioned on the ramp profile on the metal seal.

SAP Parts™ seals are available in both Alloy cast iron and Alloy forged steel grades. The o-ring material is selected from a range of premium elastomers to suit the application requirements.

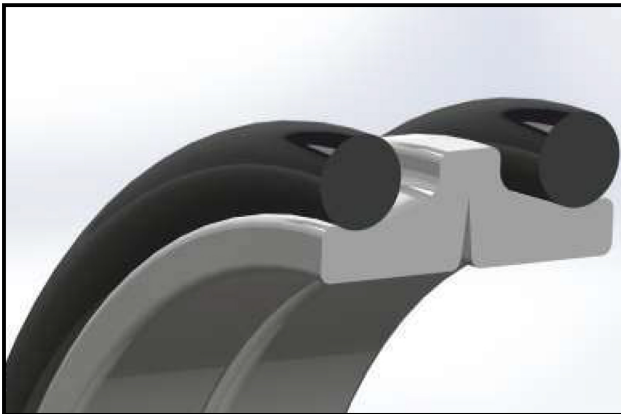

When assembled, the elastomer o-rings are compressed between the tapered contact surface of the seal ring and the housing providing suitable loading to the sealing system.

This loading is calculated by SAP Parts™ to ensure proper operation of the seal.

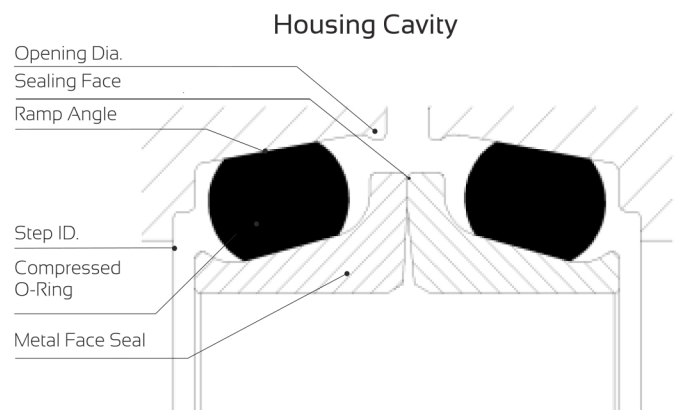
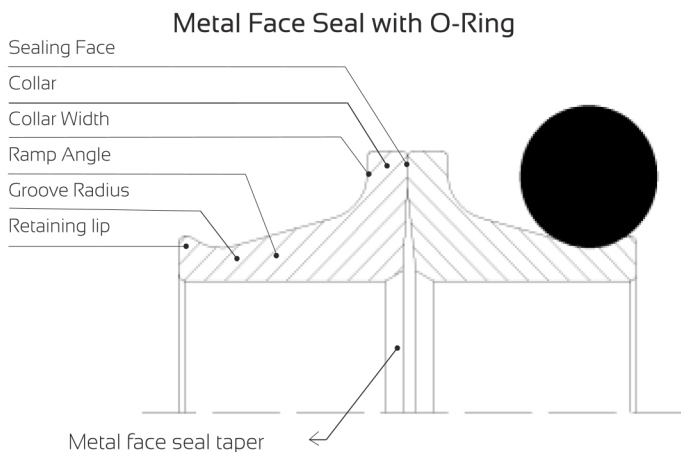

Mechanical Face Seal DF Type

DF type mechanical seals consist of two identical angular metal face seals with two trapezoid elastomer rings positioned in the housing bore.

The geometry of the housing profile is easier to produce and the seal easier to install when compared to the DO-Type seal.



Whilst the DO and DF type seals are commonly used, there are times when non-standard, specially engineered seals are required for your application.

Working directly with SAP Parts™, Sealco International's technical team can advise of the most suitable solution to meet your sealing requirements.

Assembled Condition

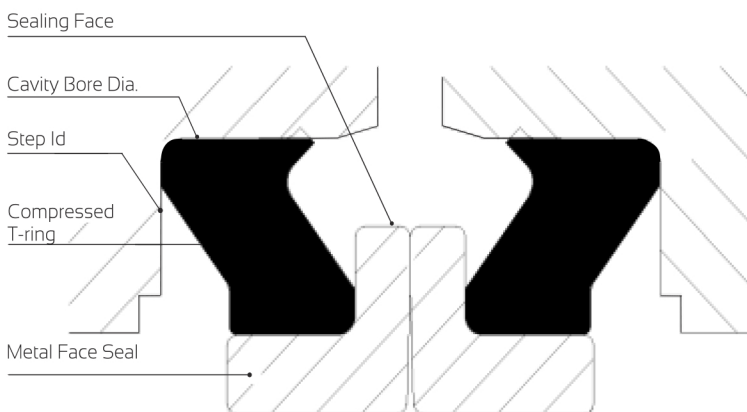

Metal Face Seal with T-Ring

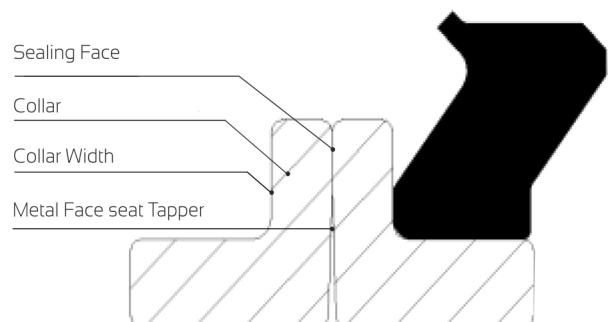

DO Type Seals parts list

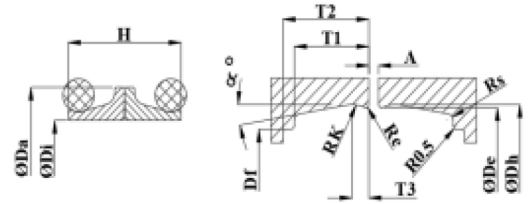

SR.No.	SAP PART No.	A	ØDa	ØDi	H	ØDh*	ØDe*	ØDf	T1	T2 min	T3	Re	Rk	Rs	α°
1	SAPC100510038020NB60	3	51	38	20	53.7	53	46	9	11	1.8	0.5	2	1	10°
2	SAPC100580045021NB60	3	58	45	21	61.6	60.8	53.4	10	12	1.8	0.3	2.5	1	10°
3	SAPC100590046020NB60	3	59	46	20	62.5	61.8	56	8.5	10.5	1.8	0.5	2	1	10°
4	SAPC106220048025NB60	3	62.15	48	25	68	67.2	58	12	14	2	0.4	3	1	10°
5	SAPC100700555022NB60	3	70	55.5	22	73.8	73.1	65.5	10	11.5	2.4	0.5	5	1	10°
6	SAPC100730602020NB60	3	73	60.2	20	76.5	75.8	69	8.5	10.5	1.8	0.5	2	1	10°
7	SAPC100780064025NB60	3	78	64	25	84.6	83.8	74	12.5	14.5	2	0.4	3	1	12°
8	SAPC100800067020NB60	3	80	67	20	83.4	82.7	76.8	8.5	10.5	1.8	0.5	2	1	10°
9	SAPC108050063026NB60	3	80.5	63	26	84	83.2	72	11.5	13	2.5	0.5	5	1	10°
10	SAPC108240635032NB60	3	82.4	63.5	32	87	86	74.5	14.5	17.5	2.8	0.5	5	1	10°
11	SAPC100840071020NB60	3	84	71	20	87.4	86.7	80.8	8.5	10.5	1.8	0.5	2	1	10°
12	SAPC108650675318NB60	3	86.5	67.5	31.8	91	90	78	14.5	17	2.8	0.5	5	1	10°
13	SAPC100890685024NB60	3	89	68.5	24	92.5	91.5	83	11	13.5	2.8	0.5	5	1	10°
14	SAPC100920073032NB60	3	92	73	32	96.5	95.5	84	14.5	17.5	2.8	0.5	5	1	10°
15	SAPC109250795020NB60	3	92.5	79.5	20	96	95.3	88	8.5	10.5	1.8	0.5	2	1	10°
16	SAPC100980081028NB60	3	98	81	28	102.3	101.3	91	12.5	14.5	2.8	0.5	5	1	10°
17	SAPC101000079030NB60	3	100	79	30	105.2	104.2	92	15	17	2.5	0.7	3	1	10°
18	SAPC101000080029NB60	3	100	80	29	104	103.2	92	14.5	16.5	2	0.4	3	1	10°
19	SAPC101020083028NB60	3	102	83	28	105.5	104.5	94	12.5	15	2.8	0.5	5	1	10°
20	SAPC110450905026NB60	3	104.5	90.5	26	107.4	106.6	100.4	11.8	14.2	2.9	1.2	2.8	1	10°
21	SAPC101080088024NB60	3	108	88	24	111.5	110.5	102	11	13.5	2.8	0.5	5	1	10°
22	SAPC110950905032NB60	3	109.5	90.5	32	114	113	101.5	14.5	17.5	2.8	0.5	5	1	10°
23	SAPC101100091032NB60	3	110	91	32	114	113	101.5	14.5	17.5	2.8	0.5	5	1	10°
24	SAPC101110962024NB60	3	111	96.2	24	115.6	114.8	108	11	12.5	1.8	0.5	2	1	10°
25	SAPC101160097032NB60	3	116	97	32	120.5	119.5	108	14.5	17.5	2.8	0.5	5	1	10°
26	SAPC101170103020NB60	3	117	103	20	119.8	119	112.5	9	11	1.8	0.5	2	1	10°
27	SAPC101190100032NB60	3	119	100	32	123.5	122.5	111	14.5	17.5	2.8	0.5	5	1	10°
28	SAPC101200099028NB60	3	120	99	28	123.5	122.5	112	12.5	14.5	2.8	0.5	5	1	10°
29	SAPC101230107023NB60	3	123	107	23	125.5	125.1	117.5	9.5	11.5	1.8	0.7	3	1	10°
30	SAPC101250104028NB60	3	125	104	28	128.5	127.5	117	12.5	14	2.8	0.5	5	1	10°
31	SAPC101250107024NB60	3	125	107	24	130.4	129.4	119.5	11	13.5	2.8	0.5	5	1	10°
32	SAPC101280110032NB60	3	128	110	32	133	132	121	15	17	2.5	0.7	3	1	12°
33	SAPC101291145021NB60	3	129	114.5	21	134.1	133.1	126	9.2	10	2.3	0.5	3	1	10°
34	SAPC101380120032NB60	3	138	120	32	143	142	132	14.5	17	2.8	0.5	5	1	10°
35	SAPC101390120318NB60	3	139	120	31.8	143.8	142.8	132	14.5	17	2.8	0.5	5	1	10°
36	SAPC113951185028NB60	3	139.5	118.5	28	143	142	131.5	12.5	15	2.8	0.5	5	1	10°
37	SAPC101400117029NB60	3	140	117	29	142.5	141.5	132	13	14	2.8	0.5	5	1	10°
38	SAPC114070127025NB60	3	140.7	127	25	144	143.2	135	12.7	15.2	2.7	1	2.8	1	10°
39	SAPC101410127029NB60	3	141	127	29	144	143	136	12	14.5	2.3	0.5	3	1	10°
40	SAPC101420120038NB60	4	142	120	38	149	148	133	17	19	2.5	0.7	3	1	10°

*This part list is for reference only. Ask for latest updates.

* F-steel version | * C- cast version

DO Type Seals parts list

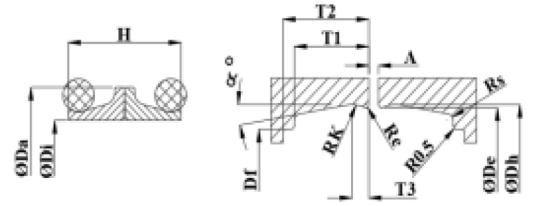

SR.No.	SAP PART No.	A	ØDa	ØDi	H	ØDh*	ØDe*	ØDf	T1	T2 min	T3	Re	Rk	Rs	α°
41	SAPC101440125318NB60	3	144	125	31.8	148.5	147.5	136	14.5	17	2.8	0.5	5	1	10°
42	SAPC101460127032NB60	3	146	127	32	150.5	149.5	138	14.5	17.5	2.8	0.5	5	1	10°
43	SAPC101460127031NB60	3	146	127	31	150.2	149.4	137	14.5	16.5	2.6	0.5	5	1	10°
44	SAPC115451355028NB60	3	154.5	135.5	28	158.3	157.3	146.5	12.5	14	2.8	0.5	5	1	10°
45	SAPC101570143027NB60	3	157	143	27	160	159	152	12	14.5	2.3	0.5	3	1	10°
46	SAPC101600143027NB60	3	160	143	27	164	163	154	12	14.5	2.8	0.5	5	1	10°
47	SAPC101670150028NB60	3	167	150	28	171	170	160	13	15.5	2.8	0.5	5	1	12°
48	SAPC101680154027NB60	3	168	154	27	171	170	162.5	12	14.5	2.3	0.5	3	1	10°
49	SAPC101690154022NB60	3	169	154	22	174.5	173.5	166	9.5	11	2.3	0.5	3	1	10°
50	SAPC101700154021NB60	3	170	154	21	175.1	174.1	167	9.2	11	2.3	0.5	3	1	10°
51	SAPC117150153028NB60	3	171.5	153	28	176.3	175.3	164.5	12.5	14.5	2.8	0.5	5	1	10°
52	SAPC117171465038NB60	3	171.7	146.5	38	176.8	175.9	158.9	18.4	20.3	3.7	0.5	6.3	1	10°
53	SAPC101720150040NB60	4	172	150	40	179	178	165	18	20	2.5	0.7	3	1	10°
54	SAPC117350154032NB60	3	173.5	154	32	178	177	166	14.5	17	2.8	0.5	5	1	10°
55	SAPC101800154038NB60	3	180	154	38	185	184	167	18	20.5	3.1	0.5	6.5	1	10°
56	SAPC118050165027NB60	3	180.5	165	27	185	184	176.5	12	14.5	2.3	0.5	3	1	10°
57	SAPC101890164030NB60	3	189	164	30	193.5	192.5	179	14.5	17	2.8	0.5	5	1	10°
58	SAPC119150163038NB60	3	191.5	163	38	196.5	195.5	178.5	18	20.5	3.1	0.5	6.5	1	10°
59	SAPC119440172318NB60	3	194.4	172	31.8	198.9	197.9	186	14.5	16.5	2.8	0.5	5	1	10°
60	SAPC101950176028NB60	3	195	176	28	199.8	198.8	188	12.5	14.5	2.8	0.5	5	1	10°
61	SAPC101990178032NB60	3	199	178	32	203.6	202.6	190	14.5	17	2.8	0.5	5	1	10°
62	SAPC102000177030NB60	3	200	177	30	204.5	203.5	191	14.5	17	2.8	0.5	5	1	10°
63	SAPC102050178038NB60	4	205	178	38	210.6	209.6	192	19	21	3	0.8	4	1	10°
64	SAPC102090192030NB60	3	209	192	30	213.5	212.5	200	14.5	17	2.8	0.5	5	1	10°
65	SAPC102100191028NB60	3	210	191	28	214	213	203	12.5	14.5	2.8	0.5	5	1	10°
66	SAPC121050182038NB60	3	210.5	182	38	215.5	214.5	197.5	18	20.5	3.1	0.5	6.5	1	10°
67	SAPC121650195318NB60	3	216.5	195	31.8	221	220	207	14.5	17	2.8	0.5	5	1	10°
68	SAPC122282087026NB60	3	222.8	208.7	26	225.4	224.4	217	11.5	13.5	2.2	0.5	2.5	1	10°
69	SAPC102270205030NB60	3	227	205	30	231.5	230.5	219	14.5	17	2.8	0.5	5	1	10°
70	SAPC122850200038NB60	3	228.5	200	38	233.5	232.5	215.5	18	20.5	3.1	0.5	6.5	1	10°
71	SAPC102370216030NB60	3	237	216	30	241.5	240.5	229	14.5	17	2.8	0.5	5	1	10°
72	SAPC123950220318NB60	3	239.5	220	31.8	244	243	232	14.5	16.5	2.8	0.5	5	1	10°
73	SAPC102410220025NB60	3	241.4	220	25	244.7	244	233.5	11	13.5	2.2	0.5	4	1	10°
74	SAPC125150223038NB60	3	251.5	223	38	256.5	255.5	238.5	18	20.5	3.1	0.5	6.5	1	10°
75	SAPC125970235038NB60	5	259.7	235	38	264.7	263.7	247	18	20.5	3.1	0.5	6.5	1	10°
76	SAPC102610238318NB60	3	261	238	31.8	265.5	264.5	254	14.5	17	2.8	0.5	5	1	10°
77	SAPC126280240038NB60	3	262.8	240	38	273.5	272.5	255.5	18	20.5	3.1	0.5	6.5	1	10°
78	SAPC126280242040NB60	3	262.8	242	40	273.5	272.5	255.5	18	20.5	3.1	0.5	6.5	1	10°
79	SAPC102700250030NB60	3	270	250	30	274.7	273.7	262	14	15.5	2.8	0.5	5	1	10°
80	SAPC128050252038NB60	3	280.5	252	38	285.5	284.5	267.5	18	20.5	3.1	0.5	6.5	1	10°

* F-steel version | * C- cast version

* This part list is for reference only. Ask for latest updates.

DO Type Seals parts list

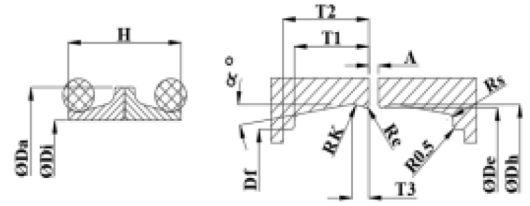

SR.No.	SAP PART No.	A	ØDa	ØDi	H	ØDh*	ØDe*	ØDf	T1	T2 min	T3	Re	Rk	Rs	α°
81	SAPC102880262040NB60	7	288	262	40	294	293	276	17	20	3.8	1.2	6	3	10°
82	SAPC102930265038NB60	3	293	265	38	298	297	280	18	20.5	3.1	0.5	6.5	1	10°
83	SAPC103030275038NB60	3	303	275	38	308	307	290	18	20.5	3.1	0.5	6.5	1	10°
84	SAPC132470300038NB60	3	324.65	300	38	335.5	334.5	318	17.5	20.5	3.1	0.5	6.5	1	10°
85	SAPC103250300038NB60	3	325	300	38	336.5	335.5	318	17.5	20.5	3.1	0.5	6.5	1	10°
86	SAPC103280300038NB60	4	328	300	38	333	332	315	19.5	22	3.1	0.8	4	1	10°
87	SAPC103410318038NB60	3	341	318	38	351.5	350.5	334	17.5	20.5	3.1	0.5	6.5	1	12°
88	SAPC103460318038NB60	3	346	318	38	351.5	350.5	334	18	20.5	3.1	0.5	6.5	1	10°
89	SAPC103540326030NB60	3	354	326	30	358.7	357.7	346	15	16.5	2.8	0.5	5	1	10°
90	SAPC136850340038NB60	3	368.5	340	38	374.8	373.2	358	19	21.5	3	0.5	4	1	10°
91	SAPC103750350038NB60	3	375	350	38	385.5	384.5	368	17.5	20.5	3.1	0.5	6.5	1	10°
92	SAPC10375035038NB60	3	375	355	38	385.5	384.5	368	17.5	20.5	3.1	0.5	6.5	1	10°
93	SAPC139440366038NB60	3	394.4	366	38	399.5	398.6	381	17.5	20.5	3	0.5	6.5	1	10°
94	SAPC139440366040NB60	6	394.4	366	40	399.5	398.6	381	17.5	20.5	3	0.5	6.5	1	10°
95	SAPC103980370038NB60	3	398	370	38	403.5	402.6	385	17.5	20.5	3	0.5	6.5	1	10°
96	SAPC104050382040NB60	6	405	382	40	412	411	395	17	22	3.8	1.1	6	3	10°
97	SAPC104150388038NB60	3	415	388	38	420.3	419.4	402	17.5	20.5	3	0.5	6.5	1	10°
98	SAPC141620388038NB60	3	416.2	388	38	421.6	420.7	402	17.5	20.5	3	0.5	6.5	1	10°
99	SAPC104570430038NB60	3	457	430	38	462.3	461.3	444	17.5	20.5	3	0.5	6.5	1	10°
100	SAPC145920430038NB60	3	459.2	430	38	464.5	463.5	444	17.5	20.5	3	0.5	6.5	1	10°
101	SAPC104800450050NB60	3	480	450	50	492.2	490.2	470	23.5	25.5	4	0.5	6	1	10°
102	SAPC104950465436NB60	3	495	465	43.6	500.7	498.5	482.9	21.2	22.9	4.7	0.7	7	1	10°
103	SAPC149720465436NB60	3	497.2	465	43.6	503.1	500.9	482.9	21.2	23	4.7	0.7	7	1	10°
104	SAPC105000470050NB60	3	500	470	50	512.2	510.2	490	23.5	25.5	4	0.5	6	1	10°
105	SAPC153340505436NB60	6	533.4	505	43.6	538.4	537.4	521	19.7	21.7	4	1.3	6.5	1	10°
106	SAPC153580505436NB60	3	535.8	505	43.6	541.8	539.7	521	19.7	21.7	4.2	0.5	6.5	1	10°
107	SAPC105480508060NB60	15	548	508	60	553	551.5	528	22	26	5	1.1	9	3	10°
108	SAPC105600530050NB60	3	560	530	50	572.2	570.2	545	23.5	25.5	4	0.5	6	1	10°
109	SAPC156680538436NB60	6	566.8	538	43.6	572.2	571.2	554	19.7	21.7	4	1.3	6.5	1	10°
110	SAPC105900559050NB60	3	590	559	50	602.2	600.2	575	23.5	25.5	4	0.5	6	1	10°
111	SAPC106080576436NB60	6	608	576	43.6	613	612	596	19.7	21.7	4	1.3	6.5	1	10°
112	SAPC106085815436NB60	6	608	581.5	43.6	613	612	596	19.7	21.7	4	1.3	6.5	1	10°
113	SAPC106230591050NB60	5.25	623	591	50	635.2	633.2	613	23.5	25.5	4	0.5	6	1	10°
114	SAPC106280596050NB60	5.25	628	596	50	640.2	638.2	618	23.5	25.5	4	0.5	6	1	10°
115	SAPC106950660053NB60	13	695	660	53	705.3	703.3	680	20	22.5	4	0.5	6	1	10°
116	SAPC107000667436NB60	9	700	667	43.6	705.6	704.3	687	21.3	24	3.7	0.7	6.3	1	10°
117	SAPC107000667050NB60	12	700	667	50	705.6	704.7	687.7	21.3	26.2	3.7	1.2	6.3	1	10°
118	SAPC107500718050NB60	3	750	718	50	762.2	760.2	740	23.5	25.5	4	0.5	6	1	10°
119	SAPC108010740080NB60	17	801	740	80	816.9	815.9	784	34.5	39.5	4.4	1.1	10	1	10°
120	SAPC108260770080NB60	17	826	770	80	831.9	830.9	800	34.5	39.5	4.4	1.1	10	1	10°

*This part list is for reference only. Ask for latest updates.

* F-steel version | * C- cast version

DO Type Seals parts list

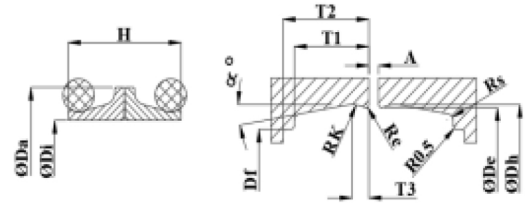

SR.No.	SAP PART No.	A	ØDa	ØDi	H	ØDh*	ØDe*	ØDf	T1	T2 min	T3	Re	Rk	Rs	α°
121	SAPC108360780080NB60	17	836	780	80	841.9	840.9	810	34.5	39.5	4.4	1.1	10	1	10°
122	SAPC108650817466NB60	12	865	817	46.6	870.6	869.7	852.7	21.3	26.2	3.8	1.2	6.3	1	10°
123	SAPC186550825048NB60	11	865.5	825	48	870.6	869.7	852.7	18.4	23.3	3.7	1.2	6.3	1	10°
124	SAPC108860834080NB60	17	886	834	80	891.9	890.9	860	34.5	39.5	4.5	1.1	10	1	10°
125	SAPC109410902060NB60	16	941	902	60	946.3	945.2	922.4	23.8	25.2	4.65	1.4	8	1	10°
126	SAPC109510890080NB60	17	951	890	80	956.9	955.9	924	30	34	4.4	1.1	10	5	10°
127	SAPC109760920080NB60	17	976	920	80	981.9	980.9	950	34.5	39.5	4.4	1.1	10	1	12°
128	SAPC110851030080NB60	17	1085	1030	80	1090.9	1089.9	1058	34.5	39.5	4.4	1.1	10	1	10°
129	SAPC111051044080NB60	17	1105	1044	80	1110.9	1109.9	1078	34.5	39.5	4.4	1.1	10	1	10°
130	SAPC112361175080NB60	26	1236	1175	80	1241.9	1240.4	1209	32.5	37.5	4.4	0.5	10	1	10°
131	SAPC114251372080NB60	26	1425	1372	80	1430.9	1429.9	1398	32.5	37.5	4.4	1.1	10	1	10°
132	SAPF100450034014NB60	1.5	45	34	14	47	46.5	42	6.5	8	1	0.5	1	1	10°
133	SAPF100500039014NB60	1.5	50	39	14	52	51.5	46	6.5	8	1	0.5	1	1	10°
134	SAPF100510038204NB60	3	51	38	20.4	53.7	53	46	9	11	1.8	0.5	2	1	10°
135	SAPF100520040020NB60	3	52	40	20	55	54.2	46	9	11	1	0.5	1	1	10°
136	SAPF100580043024NB60	3	58	43	24	61.6	60.8	53.4	10	12	1.8	0.5	2.5	1	10°
137	SAPF100580045216NB60	3	58	45	21.6	61.6	61	54	10.5	12.5	1.8	0.5	2.5	1	10°
138	SAPF100580048144NB60	1.5	58	48	14.4	59.9	59.4	55	6.3	8	1.5	0.5	1.7	1	10°
139	SAPF100590046020NB60	3	59	46	20	61.6	61.2	53	9	11	2	0.5	2.5	1	10°
140	SAPF100620048026NB60	3	62	48	26	68	67.2	58	12	14	2	0.5	3	1	10°
141	SAPF100700555022NB60	3	70	55.5	22	73.8	73.1	65.5	10	11.5	2.4	0.5	5	1	10°
142	SAPF100700056026NB60	3	70	56	26	76	75.2	66	12	14	2	0.5	2.5	1	10°
143	SAPF100730061176NB60	3	73	61	17.6	75.8	75.5	66.8	6.5	7.5	1	0.5	1.4	1	10°
144	SAPF100740062026NB60	3	74	60	20.6	78.4	77.4	70	9	11	1.9	0.5	2.5	1	10°
145	SAPF100750058027NB60	3	75	58	27	79.2	78.6	66	12	14	2	0.5	2.5	1	10°
146	SAPF107750057356NB60	-	77.5	57	35.6	81.4	80.7	68.5	15.2	20.9	3.5	0.5	4.8	1	10°
147	SAPF100780064025NB60	3	78	64	25	84.6	83.8	74	12.5	14.5	2	0.5	3	1	10°
148	SAPF108250635318NB60	3	82.5	63.5	31.8	86.5	85.7	73.5	15.2	16.8	3.5	0.5	4.8	1	10°
149	SAPF100840069024NB60	3	84	69	24	89.6	88.6	78.5	11	13	1.9	0.5	3	1	10°
150	SAPF100840071020NB60	3	84	71	20	87.4	86.7	80.8	8.5	10	1.8	0.5	2	1	10°
151	SAPF108650675318NB60	3	86.5	67.5	31.8	91	90	78	14.5	17	2.8	0.5	5	1	10°
152	SAPF108650074225NB60	3	86.5	74	22.5	91.4	90.7	80	9.5	11.5	2	0.5	3	1	10°
153	SAPF108760775136NB60	-	87.6	77.5	13.6	90.7	90.2	89.5	7.5	8	1.4	0.5	1.5	1	10°
154	SAPF108850735204NB60	3	88.5	73.5	20.4	90.2	89.4	82	12.7	14.3	2.2	0.5	2.8	1	10°
155	SAPF100890069024NB60	3	89	69	24	92.5	91.5	83	11	13.5	2.8	0.5	5	1	10°
156	SAPF100900070029NB60	3	90	70	29	95.5	94.7	84	13.5	15.5	2	0.5	3	1	10°
157	SAPF109190731318NB60	3	91.9	73.1	31.8	96	95.2	83	15.2	16.8	3.5	0.5	4.8	1	10°
158	SAPF100920725356NB60	-	92	72.5	35.6	96	95.2	83	15.2	20.9	3.5	0.5	4.8	1	10°
159	SAPF100920073318NB60	3	92	73	31.8	96.2	95.4	84	15	17	2.8	0.5	4	1	10°
160	SAPF109250795020NB60	3	92.5	79.5	20	96	95.3	88	8.5	10.5	1.8	0.5	2	1	10°

* F-steel version | * C- cast version

* This part list is for reference only. Ask for latest updates.

DO Type Seals parts list

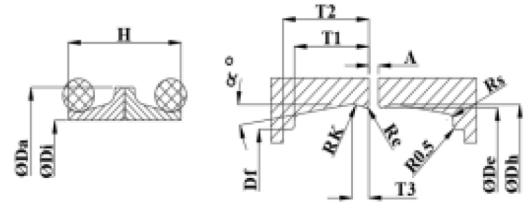

SR.No.	SAP PART No.	A	ØDa	ØDi	H	ØDh*	ØDe*	ØDf	T1	T2 min	T3	Re	Rk	Rs	α°
161	SAPF100940075029NB60	3	94	75	29	101.4	100.6	89	14.5	16.5	2	0.5	3	1	10°
162	SAPF100980081028NB60	3	98	81	28	102.3	101.3	91	12.5	14.5	2.8	0.5	5	1	10°
163	SAPF101000080030NB60	3	100	80	30	104.1	103.3	93	15	18	2.3	0.5	2.5	1	10°
164	SAPF101020825356NB60	-	102	82.5	35.6	107.3	106.5	94.3	15.2	20.9	3.5	0.5	4.8	1	10°
165	SAPF101050090026NB60	3	105	90	26	107.3	106.7	100.4	11.5	14	2.9	0.5	2.8	1	10°
166	SAPF110650094023NB60	3	106.5	94	23	111.6	110.8	102	9.5	11.5	2	0.5	3	1	10°
167	SAPF110680965136NB60	3	106.8	96.5	13.6	109.7	109.2	108.5	7.5	8	1.4	0.5	1.5	1	12°
168	SAPF101090090032NB60	3	109	90	32	112.5	111.7	104	14.5	17	3.2	0.5	3	1	10°
169	SAPF110940904318NB60	3	109.4	90.4	31.8	113.4	112.7	100.4	15.2	16.8	3.5	0.5	4.8	1	10°
170	SAPF110950904356NB60	-	109.5	90.4	35.6	113.4	112.7	100.4	15.2	20.9	3.5	0.5	4.8	1	10°
171	SAPF110950092022NB60	3	109.5	92	22	113.8	113	105	9.5	11.5	2	0.5	3	1	10°
172	SAPF101110095024NB60	3	111	95	24	115.6	114.8	108	11	12.5	1.8	0.5	2	1	10°
173	SAPF101140095032NB60	3	114	95	32	120	119.2	107	15	17	2.5	0.5	3	1	10°
174	SAPF101170104022NB60	3	117	104	22	121	120.2	107	9.5	11.5	2	0.5	3	1	10°
175	SAPF101190100318NB60	3	119	100	31.8	123	122.2	110	15.2	16.8	3.5	0.5	4.8	1	10°
176	SAPF101220103032NB60	3	122	103	32	127.2	126.2	115	15.5	17.5	2.5	0.5	3	1	10°
177	SAPF112250104225NB60	3	122.5	104	22.5	125.5	125.1	117.5	9.5	11.5	2	0.5	3	1	10°
178	SAPF101250104028NB60	3	125	104	28	128.5	127.5	117	12.5	14	2.8	0.5	5	1	10°
179	SAPF101250107024NB60	3	125	107	24	130.4	129.4	119.5	11	13.5	2.8	0.5	5	1	10°
180	SAPF101280110032NB60	3	128	110	32	133	132	121	14.5	17	2.5	0.5	3	1	10°
181	SAPF101280111022NB60	3	128	111	22	132.5	132	123	10.6	12.3	2.8	0.5	3	1	10°
182	SAPF101291145235NB60	3	129	114.5	23.5	134.1	133.1	126	10.4	11.9	2.8	0.5	5	1	10°
183	SAPF101320109032NB60	3	132	109	32	136.5	135.5	124	15.5	17.5	2.5	0.5	3	1	10°
184	SAPF101330111032NB60	5	133	111	32	137	136.5	124.5	14.5	18	2.8	0.5	5	1	10°
185	SAPF101370115031NB60	3	137	115	31	141.8	140.8	130	14.5	16.5	2.5	0.5	3	1	10°
186	SAPF101380117318NB60	3	138	117	31.8	142.5	141.5	132	14.5	17	2.8	0.5	5	1	10°
187	SAPF101390120318NB60	3	139	120	31.8	143	142	129.3	14.3	17.4	3	0.5	5.4	1	10°
188	SAPF101391265268NB60	3	139	126.5	26.8	143.8	143.1	136.9	11.8	14.2	2.9	0.5	2.8	1	10°
189	SAPF101400117028NB60	3	140	117	28	142.5	141.5	132	12.5	14	2.8	0.5	5	1	10°
190	SAPF101400119028NB60	3	140	119	28	142.5	141.5	132	12.5	14	2.8	0.5	5	1	10°
191	SAPF101410120318NB60	3	141	120	31.8	144	143	138	14.5	17.5	2.8	0.5	5	1	10°
192	SAPF101410124022NB60	3	141	124	22	146.4	145.3	136	10.6	12.3	2.8	0.5	3	1	10°
193	SAPF101410127029NB60	3	141	127	29	144	143	136	12	14.5	2.8	0.5	5	1	10°
194	SAPF114120127254NB60	3	141.2	127	25.4	143.8	143.1	136.9	11.8	14.2	2.9	0.5	2.8	1	10°
195	SAPF101420120038NB60	4	142	120	38	149	148	133	17	19	2.5	0.5	3	1	10°
196	SAPF114410125318NB60	3	144.1	125	31.8	148.5	147.5	136	14.3	17.4	3	0.5	5	1	10°
197	SAPF101460126318NB60	3	146	126	31.8	150	149.2	137	15.2	16.8	3.5	0.5	4.8	1	10°
198	SAPF101460127318NB60	4	146	127	31.8	150.5	149.5	138	14.5	17.5	2.8	0.5	5	1	10°
199	SAPF115050130032NB60	3	150.5	130	32	155.6	154.6	144	14.5	16.5	2.5	0.5	5	1	10°
200	SAPF101520130385NB60	-	152	130	38.5	159	158	144	18.5	20.5	2.5	0.5	3	1	10°

*This part list is for reference only. Ask for latest updates.

* F-steel version | * C- cast version

DO Type Seals parts list

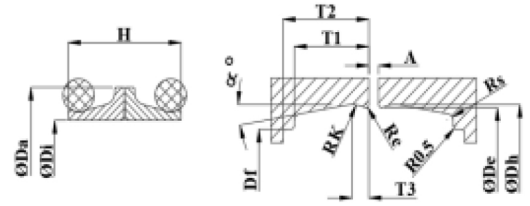

SR.No.	SAP PART No.	A	ØDa	ØDi	H	ØDh*	ØDe*	ØDf	T1	T2 min	T3	Re	Rk	Rs	α°
201	SAPF115691427254NB60	3	156.9	142.7	25.4	159.7	158.9	152.1	11.8	14.2	2.9	0.5	2.8	1	10°
202	SAPF101570144026NB60	3	157	144	26	160	159	154.5	12	14.5	2.8	0.5	5	1	10°
203	SAPF101600143027NB60	4	160	143	27	164	163	154	12	14.5	2.8	0.5	5	1	10°
204	SAPF101670147028NB60	3	167	147	28	171	170	160	13	15.5	2.8	0.5	5	1	10°
205	SAPF101680146038NB60	4	168	146	38	176.8	175.9	159	18	20.5	3	0.5	6.5	1	10°
206	SAPF101680154027NB60	3	168	154	27	171	170	162.5	12	14.5	2.3	0.5	3	1	10°
207	SAPF116811539254NB60	3	168.1	153.9	25.4	171	170.2	164	11.8	14.2	2.9	0.5	2.8	1	12°
208	SAPF101690154022NB60	3	169	154	22	174.5	173.5	166	9.2	11	2.3	0.5	3	1	10°
209	SAPF101700148031NB60	4	170	148	31	175.6	174.6	164	15	17	2.5	0.5	3	1	10°
210	SAPF101700154021NB60	3	170	154	21	175.1	174.1	167	9.2	10	2.3	0.5	3	1	10°
211	SAPF117150152032NB60	-	171.5	152	32	175.4	174.7	162.5	15.2	16.8	3.5	0.5	4.8	1	10°
212	SAPF117150153028NB60	3	171.5	153	28	176.3	175.3	164.5	12.5	14.5	2.8	0.5	5	1	10°
213	SAPF117171463038NB60	-	171.7	146.3	38	176.8	175.9	158.9	18.4	20.3	3.7	0.5	6.3	1	10°
214	SAPF101720150040NB60	4	172	150	40	179	178	165	18	20	2.5	0.5	2	1	10°
215	SAPF117350154032NB60	3	173.5	154	32	178	177	166	14.5	17	2.8	0.5	6.5	1	10°
216	SAPF101750146038NB60	6	175	146	38	180.5	179.5	162	17.7	20.5	3	0.5	6.3	1	10°
217	SAPF101810165027NB60	3	181	165	27	185	184	176.5	12	14.5	2.7	0.5	4	1	10°
218	SAPF101890164030NB60	3	189	164	30	193.5	192.5	179	14.5	17	2.8	0.5	5	1	10°
219	SAPF101901725254NB60	3	190	172.5	25.4	192.7	191.8	188	12.7	14.3	2.3	0.5	2.8	1	10°
220	SAPF101900174254NB60	3	190	174	25.4	192.7	191.8	188	12.7	14.3	2.3	0.5	2.8	1	10°
221	SAPF119121633038NB60	6	191.2	163.3	38	196.8	195.8	178.9	18.4	20.3	3.7	0.5	6.3	1	10°
222	SAPF119131633046NB60	6	191.3	163.3	46	196.8	195.9	178.9	18.4	24.1	3.7	0.5	6.3	1	10°
223	SAPF119740180214NB60	3	197.4	180	21.4	202.2	201.9	196	9.4	10.6	1.2	0.5	3	1	10°
224	SAPF101990178032NB60	3	199	178	32	203.6	202.6	190	14.5	17	2.8	0.5	5	1	10°
225	SAPF102000177031NB60	3	200	177	31	204.5	203.4	191	14.5	17	3.1	0.5	5	1	10°
226	SAPF102000178038NB60	4	200	178	38	210.6	209.6	192	19	21	3	0.5	4	1	10°
227	SAPF102020183028NB60	3	202	183	28	206	205	195	12.5	14.5	2.8	0.5	5	1	10°
228	SAPF102030186254NB60	3	203	186	25.4	205.7	204.9	190.5	14.5	16	2.3	0.5	2.8	1	10°
229	SAPF102100191028NB60	3	210	191	28	214	213	203	12.5	14.5	2.8	0.5	5	1	10°
230	SAPF121031823038NB60	6	210.3	182.3	38	215.4	214.4	197.5	18.4	20.3	3.7	0.5	6.3	1	10°
231	SAPF121031824046NB60	6	210.3	182.4	46	215.4	214.4	197.5	18.4	24.1	3.7	0.5	6.3	1	10°
232	SAPF102150192033NB60	4	215	192	33	220.8	219.8	207	16.5	18.5	3	0.5	4	1	10°
233	SAPF121650195032NB60	3	216.5	195	32	221	220	207	14.5	17	2.8	0.5	5	1	10°
234	SAPF122230202265NB60	3	222.3	202	26.5	224.9	224.1	217.9	11.8	14.2	2.9	0.5	2.8	1	10°
235	SAPF102270205030NB60	3	227	205	30	231.5	230.5	219	14.5	17	2.8	0.5	5	1	10°
236	SAPF122850200038NB60	6	228.5	200	38	233.5	232.5	215.5	18	20.5	3.1	0.5	6.3	1	10°
237	SAPF102340209042NB60	4	234	209	42	242.6	241.6	224	19.5	22.5	3	0.5	4	1	10°
238	SAPF123950220032NB60	3	239.5	220	32	244	243	232	14.5	16.5	2.8	0.5	5	1	10°
239	SAPF125142235038NB60	6	251.4	223.5	38	256.5	255.7	238.7	18.4	20.3	3.7	0.5	6.3	1	10°
240	SAPF125152235046NB60	6	251.5	223.5	46	256.6	255.7	238.7	18.4	24.1	3.7	0.5	6.3	1	10°

* This part list is for reference only. Ask for latest updates.

* F-steel version | * C- cast version

DO Type Seals parts list

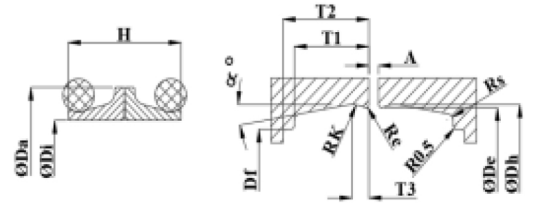

SR.No.	SAP PART No.	A	ØDa	ØDi	H	ØDh*	ØDe*	ØDf	T1	T2 min	T3	Re	Rk	Rs	α°
241	SAPF102520225038NB60	4	252	225	38	258	257	241	19	21	3	0.5	4	1	10°
242	SAPF125962316038NB60	6	259.6	231.6	38	264.7	263.8	247	18.4	20.5	3.7	0.5	6.3	1	10°
243	SAPF102610238032NB60	3	261	238	32	265.5	264.5	254	14.5	17	2.8	0.5	5	1	10°
244	SAPF126280240038NB60	3	262.8	240	38	273.5	272.5	255.5	18	20.5	3.1	0.5	6.5	1	10°
245	SAPF126450245032NB60	3	264.5	245	32	268.9	267.9	255	14.5	17	2.8	0.5	5	1	10°
246	SAPF102680239040NB60	4	268	239	40	274.2	273.2	257	20.5	22.5	3	0.5	4	1	10°
247	SAPF102760250044NB60	4	276	250	44	284.6	283.6	266	20.5	24	3	0.5	4	1	12°
248	SAPF102800252038NB60	3	280	252	38	285.5	284.5	265	18	20	3.1	0.5	6.5	1	10°
249	SAPF129280265046NB60	6	292.8	265	46	297.8	297	280	18.4	24.1	3.7	0.5	6.3	1	10°
250	SAPF102930265038NB60	4	293	265	38	298	297	280	18	20.5	3.1	0.5	6.3	1	10°
251	SAPF103030275038NB60	3	303	275	38	308	307	290	18	20.5	3.1	0.5	6.5	1	10°
252	SAPF131082829038NB60	6	310.8	282.9	38	316.3	315.4	298.4	18.4	20.3	3.7	0.5	6.3	1	10°
253	SAPF103250300038NB60	3	325	300	38	335.5	334.5	318	17.5	20.5	3.1	0.5	6.5	1	10°
254	SAPF103280300040NB60	4	328	300	40	333	332	315	18.5	21	3	0.5	4	1	10°
255	SAPF103280301038NB60	6	328	301	38	333	332.1	315.1	18.4	20.3	3.7	0.5	6.3	1	10°
256	SAPF103410318038NB60	3	341	318	38	351.5	350.5	334	18	20.5	3.1	0.5	6.5	1	10°
257	SAPF134643185038NB60	6	346.4	318.5	38	351.6	350.7	333.7	18.4	20.3	3.7	0.5	6.3	1	10°
258	SAPF134650319046NB60	6	346.5	319	46	351.6	350.7	333.7	18.4	24.1	3.7	0.5	6.3	1	10°
259	SAPF103680340040NB60	3	368	340	40	374.8	373.8	358	19	21.5	3	0.5	4	1	10°
260	SAPF103693395040NB60	4	369	339.5	40	374.8	373.8	358	19	21.5	3	0.5	4	1	10°
261	SAPF103750350038NB60	3	375	350	38	385	384.5	368	17.5	20.5	3.1	0.5	6.5	1	10°
262	SAPF139443665038NB60	6	394.4	366.5	38	399.5	398.6	381.7	18.4	20.3	3.7	0.5	6.3	1	10°
263	SAPF139453665048NB60	6	394.5	366.5	48	399.5	398.6	381.7	18.4	24.1	3.7	0.5	6.3	1	10°
264	SAPF139453672038NB60	6	394.5	367.2	38	399.5	398.6	381.7	18.4	20.3	3.7	0.5	6.3	1	10°
265	SAPF103980370038NB60	3	398	370	38	403.5	402.6	385	17.5	20.5	3	0.5	6.5	1	10°
266	SAPF104053805040NB60	4	405	380.5	40	412.2	410.5	395	17	22	3	0.5	4	1	10°
267	SAPF104150387038NB60	3	415	387	38	420.3	419.3	402	17.5	20.5	3.1	0.5	6.5	1	10°
268	SAPF104544285037NB60	4	454	428.5	37	462.3	461.3	444.6	18.5	21	3	0.5	4	1	10°
269	SAPF145724292038NB60	6	457.2	429.2	38	462.3	461.4	444.4	18.4	20.3	3.7	0.5	6.3	1	10°
270	SAPF105000470050NB60	3	500	470	50	512.2	510.2	490	23.5	25.5	13	0.5	6	1	10°
271	SAPF153345054044NB60	6	533.4	505.4	44	538.5	537.6	520.6	21.3	26.2	3.7	0.5	6.3	1	10°
272	SAPF105600530050NB60	3	560	530	50	572.2	570.2	545	23.5	25.5	4	0.5	6	1	10°
273	SAPF106080580436NB60	6	608	580	43.6	613	611	596	19.7	21.7	4	0.5	6.5	1	10°
274	SAPF106230591050NB60	5	623	591	50	635.2	632.1	613	23.5	25.5	4	0.5	6	1	10°
275	SAPF107000667044NB60	6	700	667	44	705.6	704.6	687.6	18.4	23.4	3.7	0.5	6.3	1	10°
276	SAPF107500710050NB60	3	750	710	50	762.2	760.2	740	23.5	25.5	4	0.5	6	1	10°
277	SAPF108860830080NB60	17	886	830	80	891.6	890.6	860	34.5	39.5	4.4	0.5	10	1	10°

* F-steel version | * C- cast version

* This part list is for reference only. Ask for latest updates.

DF Type Seals parts list

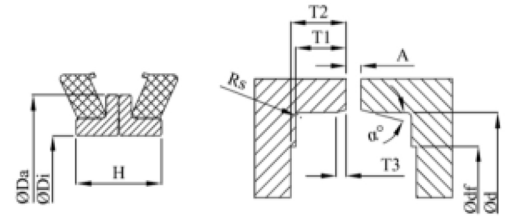

SR.No.	SAP PARTS NO.	A	Ø Da	Ø Di[mm]	H	Ø d	Ø df	T1	T2	T3	Rs	α°
1	SAPC1L62500485256NB60	22.7	62.5	48.5	25.6	76.3	62.9	10.6	14	1.6	1	30°
2	SAPC1L00650045022NB60	24.7	65	45	22	70.1	58	11.5	12.1	1.5	1	30°
3	SAPC1L00760056021NB60	22.9	76	56	21	82.6	70.1	10.6	11.7	1	1	30°
4	SAPC1L00800060024NB60	28	80	60	24	85	70	10.5	10.5	1	1	30°
5	SAPC1L00900076017NB60	18	90	76	17	95	83	8	9.5	1	1	30°
6	SAPC1L00930735020NB60	23.3	93	73.5	20	102.4	88.4	10.8	11.2	1	1	30°
7	SAPC1L01040088019NB60	20	104	88	19	113	98	8	9.5	1	1	20°
8	SAPC1L01200094025NB60	27.8	120	94	25	125.8	109.1	13	13.6	1.5	1	30°
9	SAPC1L01410115028NB60	33.5	141	115	28	152.4	131.4	15.9	15.9	1.5	1	30°
10	SAPC1L01580132031NB60	34	158	132	31	171.5	151.8	15.4	15.9	1.5	1.5	30°
11	SAPC1L01611425024NB60	27.7	161	142.5	24	173	139.7	11.1	11.3	1.5	1	30°
12	SAPC1L01720148029NB60	34.7	172	148	29	184.5	164.7	16.5	16.5	1.5	1.5	30°
13	SAPC1L02180192032NB60	32.2	218	192	32	231	206	15.2	17.1	1	1.5	30°
14	SAPC1L02380201036NB60	44.5	238	201	36	254	235.5	21.2	21.2	1	1.5	30°
15	SAPC1L02382135274NB60	32	238	213.5	27.4	254	240	13.7	13.7	1.5	1	30°
16	SAPC1L02640239034NB60	36.5	264	239	34	279.4	261.9	17.5	18.2	1.6	1	45°
17	SAPC1L02650225040NB60	48.9	265	225	40	277.1	247.8	23.7	23.7	1.5	1.5	30°
18	SAPC1L02652357030NB60	33.8	265	235.7	30	273.1	230	15.6	15.7	1.5	1	30°
19	SAPC1L02820256030NB60	32.8	282	256	30	292.1	276.2	15.6	16.2	1.5	1	30°
20	SAPC1L03190283034NB60	39.1	319	283	34	329.4	307.3	18.5	18.5	1.5	1	45°
21	SAPC1L03530319036NB60	42.1	353	319	36	365.1	343.7	20	20	1.6	1.5	30°
22	SAPF1L00590042020NB60	24	59	42	20	65	53	10	10.5	2	1	15°
23	SAPF1L00620047020NB60	25	62	47	20	70	58	10	11	2	1	15°
24	SAPF1L00650505019NB60	24.5	65	50.5	19	76.2	63	10	11	2	1	15°
25	SAPF1L00730054022NB60	27	73	54	22	80	67	11.5	12	1.5	1	15°
26	SAPF1L00730585019NB60	#REF!	73	58.5	19	82.5	65	10	10	2	1	15°
27	SAPF1L00800586196NB60	22	80	58.6	19.6	84	71	9	9.5	1.5	1	15°
28	SAPF1L00810635019NB60	22	81	63.5	19	87.8	71	9	9.5	1	1	15°
29	SAPF1L08620067020NB60	25	86.2	67	20	95.4	82	10	11	2	1	15°
30	SAPF1L08620068020NB60	25.5	86.2	68	20	95.6	82	10	11	2	1	15°
31	SAPF1L00870067025NB60	30	87	67	25	95	81	12.5	13	1.5	1	15°
32	SAPF1L09170067020NB60	25	91.7	67	20	95.4	82	10	11	2	1	15°
33	SAPF1L09280738020NB60	25	92.8	73.8	20	102.2	88	10	11	2	1	15°
34	SAPF1L00970077025NB60	31	97	77	25	105	87	12.5	13.5	1.5	1	15°

* This part list is for reference only. Ask for latest updates.

* F-steel version | * C- cast version

DF Type Seals parts list

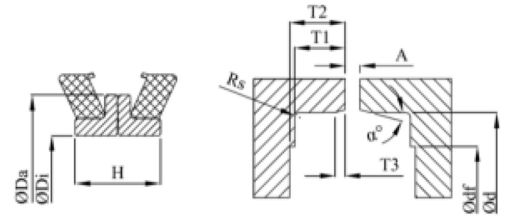

SR.No.	SAP PARTS NO.	A	Ø Da	Ø Di[mm]	H	Ø d	Ø df	T1	T2	T3	Rs	α°
35	SAPF1L00990074020NB60	25	99	74	20	102.2	88	10	11	2	1	15°
36	SAPF1L01000825022NB60	27.5	100	82.5	22	114.3	97	11	12	2	1	15°
37	SAPF1L10150817020NB60	25	101.5	81.7	20	110.2	96	10	11	2	1	15°
38	SAPF1L01090875175NB60	22	109	87.5	17.5	113	100	8.5	9.5	1.5	1	15°
39	SAPF1L11150875019NB60	25	111.5	87.5	19	115.8	102	10	11	1.5	1	15°
40	SAPF1L11250094024NB60	29	112.5	94	24	125.8	109	12.5	13	2.5	1	15°
41	SAPF1L01130092024NB60	29	113	92	24	125.8	109	12.5	13	2.5	1	15°
42	SAPF1L01200099175NB60	22	120	99	17.5	124	110	8.5	9.5	1.5	1	15°
43	SAPF1L01230099019NB60	25	123	99	19	127.3	113	10	11	3	1	15°
44	SAPF1L01240105244NB60	32	124	105	24.4	134.9	125	13.3	14.5	1.5	1	15°
45	SAPF1L01260104024NB60	30	126	104	24	135	114	12	13	2	1	15°
46	SAPF1L13320114026NB60	30	133.2	114	26	147.9	130	12	13	1.5	1	15°
47	SAPF1L01380114026NB60	30	138	114	26	148	126	12	13	2	1	15°
48	SAPF1L01440124032NB60	44	144	124	32	162.5	141.5	18.5	20.5	1.5	1	15°
49	SAPF1L01560133028NB60	34.5	156	133	28	171.5	151	13	14	2	1	15°
50	SAPF1L01681485324NB60	40	168	148.5	32.4	184.1	164	16.5	17.5	1.5	1	15°
51	SAPF1L01750150030NB60	36	175	150	30	190	170	15	15.5	2	1	15°
52	SAPF1L01800154036NB60	44.5	180	154	36	194	174	18.4	20	1.4	1	15°
53	SAPF1L01800158018NB60	26	180	158	18	190	174	8	10	1	1	15°
54	SAPF1L01950169033NB60	41.8	195	169	33	206.2	191.5	15.1	18.4	1.1	1	15°
55	SAPF1L02071777029NB60	35	207	177.7	29	218.9	197	16.6	17.5	1.6	1	15°
56	SAPF1L21430193031NB60	43.8	214.3	193	31	238.9	215	19.4	20.4	1.4	1	15°
57	SAPF1L21450194031NB60	42	214.5	194	31	238.8	214	20.1	21	1.1	1	15°
58	SAPF1L02240198035NB60	41	224	198	35	245	223	17	17.5	2	1	15°
59	SAPF1L02590233035NB60	42	259	233	35	280	250	17	18	2	1	15°
60	SAPF1L26050228041NB60	#REF!	260.5	228	41	277.1	247.5	23.5	24.5	1.5	1	15°
61	SAPF1L27352415036NB60	42	273.5	241.5	36	279.4	260.6	17.5	20	1	1	15°
62	SAPF1L03030275036NB60	42	303	275	36	309.4	290	17.5	20	1	1	15°
63	SAPF1L03050283042NB60	47.2	305	283	42	329.4	307	18.5	22.1	1.5	1	15°
64	SAPF1L35250320040NB60	45	352.5	320	40	365.1	343	20	21.5	1.5	1	15°
65	SAPF1L03920355396NB60	49.8	392	355	39.6	401.7	380	23	24	1.5	1	15°
66	SAPF1L04700442041NB60	46.5	470	442	41	488.7	467	18.4	22	1.4	1	15°
67	SAPF1L05300492043NB60	50.8	530	492	43	546.1	532	19.9	24.4	1.5	1	15°

For Further Information

For more technical information and for guidance on installation/installation tools, material data, application suitability and any other questions, please contact our sales teams at any of our UK facilities for more information.

Offering an industry leading range of sealing products, Sealco International are the UK's leading independent seal supplier with locations across the UK. We hold extensive stock of standard products and our in-house manufacturing of bespoke sealing products allow us to produce the optimum seal for your application when you need it.

Our sales and engineering team are ready to assist you whatever your sealing requirements.

sales@sealco.co.uk



Head Office:

Sealco International Ltd
Sealco House
Maypole Fields
Halesowen
West Midlands
B63 2QB

+44 (0)1384 413058

Aberdeenshire:

Sealco International Ltd
Unit 18
Castle Park Ind. Est.
Ellon
Aberdeenshire
AB41 9RF

+44 (0)1358 280225

Paignton:

ASeal Plastics
Unit 10
Torbay Business Park
Woodview Road
Paignton
TQ4 7HP

+44 (0)1803 540262